

Accessories



Accessories Catalogue - Issue 4

Multi Line Accessories



Pump Elements

For XGS, AX and AC Pumps



Colour	Stroke output cc	For 4mm tube	For 3/16"mm tube	For 6mm tube
Red	0.010	78033	78043	78053
Green	0.015	78034	78044	78054
Yellow	0.025	78035	78045	78055
Blue	0.040	78036	78046	78056
Grey	0.060	78037	78047	78057
Black	0.100	78038	78048	78058

3/16" & 6mm sizes available on request

Blanking Plugs



Part No	Description
34237-402	Pump Blanking Plug To blank off unused ports on multi-line pumps Thread size M12 x 1

Nylon Tube



Part No	Description
152823/25	4mm OD primed with 000 grade grease 25m coil
152823/50	4mm OD primed with 000 grade grease 50m coil
152821/25	4mm OD primed with NLGI 2, 25m coil
152058	5mm OD for XGS air system

Multi Line Accessories

PUSH - IN FITTINGS

Straight Connectors



Part No	Description
PM 80412	4mm OD x 1/8" PTF SAE
PM 80484	4mm OD x 1/4" x 28UNF
PM 80485	4mm OD x 5/16" x 24UNF
PM 80487	4mm OD x 1/8" BSPT
PM 80489	4mm OD x M6 x 1P
PM 80490	4mm OD x M8 x 1P
PM 80491	4mm OD x M8 x 1.25P
PM 80492	4mm OD x M10 x P
PM 80493	4mm OD x M10 x 1.5P
25478-056	4mm OD x 4mm OD CONNECTOR
25487-020	5mm 1/8BSPT
25487-023	6mm 1/8BSP
25487-024	4mm 1/8BSPT
25487-025	6mm M8 x 1
25487-056	4mm M5 x 0.8
25487-058	8mm 1/4BSP
25477-904	5mm 1/8BSP St.

90 Degree Elbows



PM 90412	4mm OD x 1/8" PTF SAE
PM 90484	4mm OD x 1/4" x 28UNF
PM 90485	4mm OD x 5/16" x 24UNF
PM 90487	4mm OD x 1/8" BSPT
PM 90489	4mm OD x M6 x 1P
PM 90490	4mm OD x M8 x 1P
PM 90491	4mm OD x M8 x 1.25P
PM 90492	4mm OD x M10 x P
PM 90493	4mm OD x M10 x 1.5P
25487-031	4mm Swivel elbow 1/4BSP
25487-043	6mm Swivel elbow 1/8BSP
25487-044	4mm Swivel elbow 1/8BSP
25487-045	6mm Swivel elbow 1/4BSP
25487-059	8mm Swivel elbow 1/4BSP
25487-064	4mm Swivel elbow M6 x 1
25478-051	5mm Swivel elbow M12 x 1

Conduit/Spiral binding



1837-001	Spiral binding 6mm ID 1-2 tubes
1837-002	Spiral binding 8mm ID 3-4 tubes
1837-003	Spiral binding 10mm 5-3 tubes
1837-004	Spiral binding 14mm 8-12 tubes
1837-005	Spiral binding 20mm 12 -18 tubes
27315 - 907	Split Conduit 7mm
27315 - 910	Split Conduit 10mm
27315 - 912	Split Conduit 12mm
27315 - 917	Split Conduit 17mm

Numbered Sleeves



OA 50397/1	for up to 12 point system
OA 50397/2	for up to 13-24 point system
OA 50397/3	for up to 25-36 point system
OA 50397/4	for up to 37-48 point system
OA 50397/5	for up to 49-60 point system

Metered/Positive Displacement Accessories



Lubeplus E



Lubeshot



GX Pump with in built controller

Flow value/Output guide

Flow Value	Output at 100psi in cc/min
20	0.10
21	0.20
22	0.40
23	0.80
24	1.60
25	3.20
26	6.40
27	12.80
28	25.6
29	51.2

Meter Valves (0.8 -25 Bar)

(Medium Pressure System)

Junction IM Screwed into tapped holes or junctions when feeding bearings through tail pipes	Flow Value	Part No	Tee IH Used where connection is made with the main supply through a junction header	Flow Value	Part No
	20	IM20		20	IH20
	21	IM21		21	IH21
	22	IM22		22	IH22
	23	IM23		23	IH23
	24	IM24		24	IH24
	25	IM25		25	IH25
	26	IM26		26	IH26
	27	IM27		27	IH27
	28	IM28		28	IH28
29	IM29	29	IH29		
Straight IW For direct connection into bearings. Mounted directly at the bearing and used at the end of pressure lines	20	IW20	Straight IB Mounted directly at the bearing and used at the end of pressure lines	20	IB20
	21	IW21		21	IB21
	22	IW22		22	IB22
	23	IW23		23	IB23
	24	IW24		24	IB24
	25	IW25		25	IB25
	26	IW26		26	IB26
	27	IW27		27	IB27
	28	IW28		28	IB28
	29	IW29		29	IB29

Positive Displacement Valves

(10 - 30 Bar)

Manifold Mounted			
Part No	Discharge Volume (cc)	Thread 'B'	Dim 'A' (mm)
PD2403	0.03	1/8in BSPT	40
PD2406	0.06		40
PD2410	0.10		40
PD2416	0.16		40
Supplied complete with sealing washer			

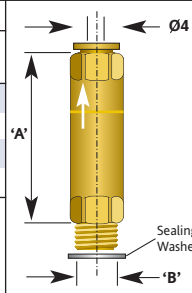

Bearing Mounted			
Part No	Discharge Volume (cc)	Thread 'B'	Dim 'A' (mm)
PD3103	0.03	1/8in BSPT	51.5
PD3106	0.06		51.5
PD3110	0.10		51.5
PD3116	0.16		51.5
PD3125	0.25		57.5
PD3140	0.40		57.5
PD3160	0.60		57.5
Supplied complete with nut and cone			

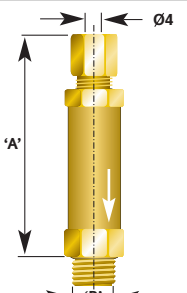

Available on request contact Interlube



Manifold Mounted			
Part No	Discharge Volume (cc)	Thread 'B'	Dim 'A' (mm)
PD3403	0.03	M8 x 1	49.5
PD3406	0.06		49.5
PD3410	0.10		49.5
PD3416	0.16		49.5
PD3425	0.25		57.5
PD3440	0.40		57.5
PD3460	0.60		57.5
Supplied complete with nut, cone & sealing washer			

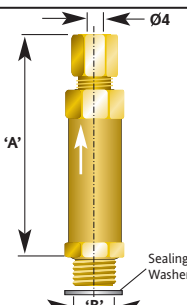

Metered/Positive Displacement Accessories

Metered Valves/Positive Displacement

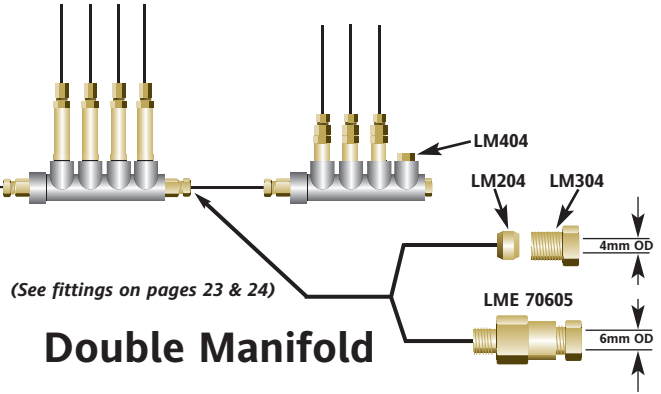
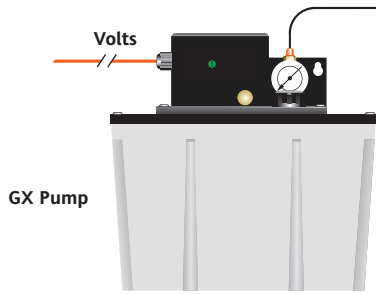

Single Manifold



MM6 shown

4 to 12 Way Single Manifolds				
Type	Part No	'A'	'B'	'C'
4-way	MMS4	50.0	35.0	2
5-way	MMS5	65.0	51.0	3
6-way	MMS6	86.0	68.0	4
7-way	MMS7	98.0	80.0	5
8-way	MMS8	115.0	94.0	6
10-way	MMS10	137.0	123.0	8
12-way	MMS12	166.0	151.0	10

All ports M8x1

Double Manifold



MMD 14 shown

4 to 12 Way Single Manifolds				
Type	Part No	'A'	'B'	'C'
6-way	MMD6	48.0	35.0	4
8-way	MMD8	65.0	51.0	6
10-way	MMD10	83.0	70.0	8
12-way	MMD12	97.0	83.0	10
14-way	MMD14	112.0	99.0	12

All ports M8x1

JUNCTION & JUNCTION HEADERS

Junctions

Manufactured from Zinc Alloy suitable for 4mm (5/32") OD tubing

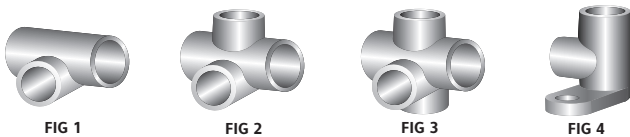

Part No	Description
114829	2 way junction Fig 1
114830	3 way junction Fig 2
114831	4 way junction Fig 3
118278	2 way junction Fig 4

Junctions Headers

Manufactured from Zinc Alloy, one hole tapped 1/8"NPT. Remaining holes tapped for 4mm (5/32) OD tubing

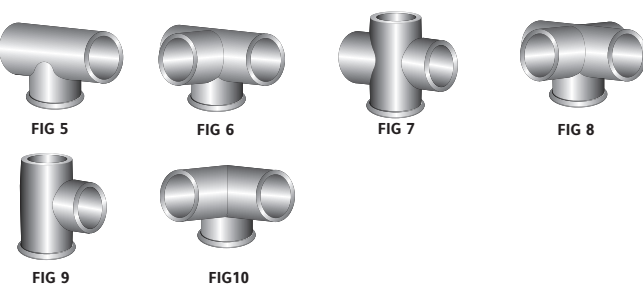

Part No	Description
114837	2 way junction Fig 5
114838	3 way junction Fig 6
114839	4 way junction Fig 7
114840	5 way junction Fig 8
114841	3 way junction Fig 9
114843	3 way junction Fig 10

Switches & Filters

Pressure Switches

(All spade terminals & 1/4 BSPM fixing unless otherwise stated)



Part No	Description
23773-019	Pressure range 0.1-1bar N.O.
23773-023	Pressure range 1-10 bar N.O. set at 3 bar
23773-024	Pressure range 10-20 bar N.O. set at 12 bar
23773-025	Pressure range 10-20 bar N.O. set at 15 bar
23773-032	Pressure range 10-20 bar N.O. set at 12 bar with fly leads.
23773-035	Pressure range 10-20 bar N.O. set at 12 bar with viton membrane & gold contacts.
23773-030	Rubber cap to fit above pressure switches

Float Switches/Level Sensors

Part No	Description
FSI-087	N.C. STD on 1/2 & 1 litre Lubepplus "E"
FSI-087/NO	N.O. option on 1/2 & 1 litre Lubepplus "E"
FSI-148	N.C. STD on 2 litre Lubepplus "E"
FSI-148/NO	N.O. option on 2 litre Lubepplus "E"
FSI-165	N.C. used on MGP19142
FS3-148	N.C. used on cont running GX pumps
FS3-148/NO	N.O. option for cont running GX pumps
FS3-220	N.C. used with 12 litre steel reservoirs
FS3-220/NO	N.O.option for use with 12 litre ST. reservoirs
FS3-260	N.C. used with 25 litre steel reservoirs
FS4M-140	N.C. used with FG. TX pumps
FS7-148	N.C. All GX oil pumps 3 & 6 litre versions
FS7-148/NO	N.C. option for GX oil pumps 3 & 6 litre
*FS8-100	N.C. used FG versions of AC3, AX3 + 3 Litre SLC pumps
*HDI/SP5/6	N.C. used on 6 litre HDI pumps
*HDI/SP5/9	N.C. used on 9 litre HDI pumps
*HDI/SP5/15	N.C. used on 15 litre HDI pumps
*FSI0-150	N.O. used on 6 litre HDI pumps
*FSI0-240	N.O. used on 9 litre HDI pumps
*FSI0-450	N.O. used on 15 litre HDI pumps
*GX/SPI	N.C. used on 3 & 6 litre FG GX pump+molex
*GX/SP2	N.C. used on 3 & 6 litre FG GX pump less+molex

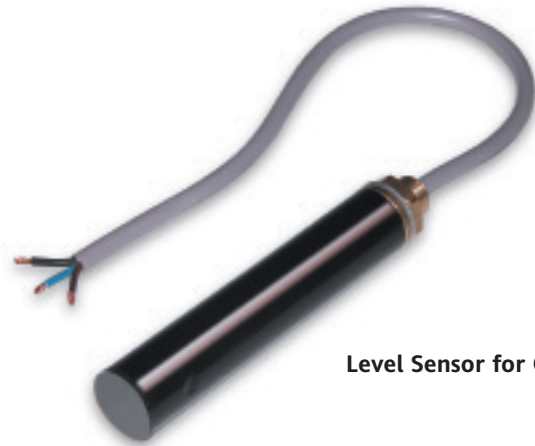

Level Sensor for Grease



Level Sensor for Oil

NOTE: N.C. - Normally closed when reservoir full

N.O. - Normally open when reservoir full

*Solid State Capacitive Sensors

Dynamic - Positive Displacement System



1:9 Ratio piston pump

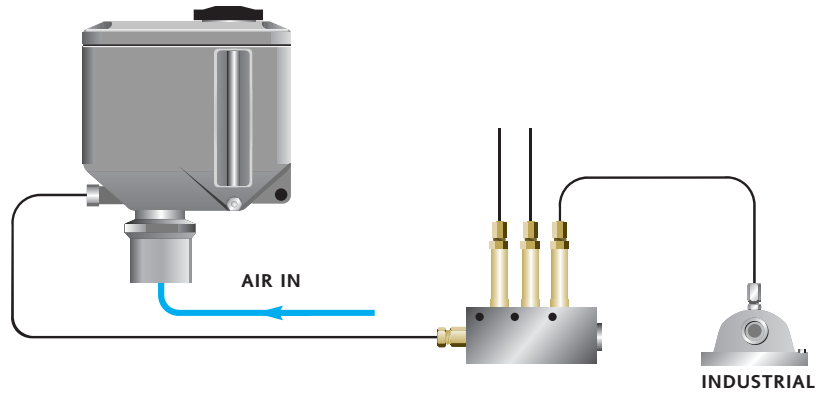

Dynamic systems operate at high pressure and can cycle repeatedly quicker than most standard Positive displacement systems, and can be used with oils and fluid greases up to NLGI 00/000.

Dynamic Valves (15-100 Bar)

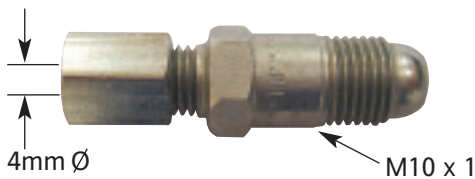

Part No	Valve type	Output per cycle (cc)
28090-052	Dynamic Valve (5)	0.005
28090-102	Dynamic Valve (10)	0.01
28090-252	Dynamic Valve (25)	0.025
28090-502	Dynamic Valve (50)	0.050
28091-102	Dynamic Valve (100)	0.10
28091-252	Dynamic Valve (250)	0.25
28091-502	Dynamic Valve (500)	0.50
28092-102	Dynamic Valve (1000)	1.00

Manifolds

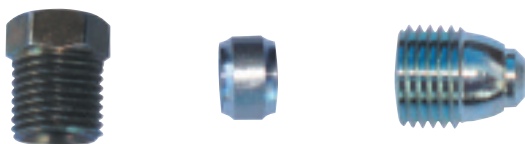
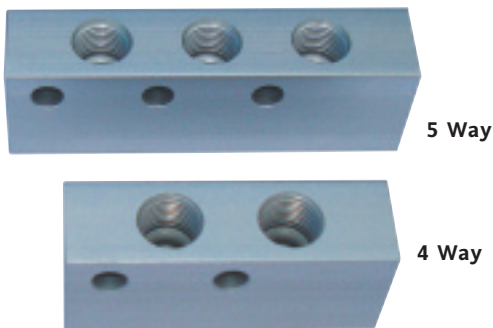

Deutsche Tecalemit Fittings for Dynamic PDU Systems

Manifolds Part No	Description
43113-101	3 way single M10x1 threads
43113-201	4 way single M10x1 threads
43113-301	5 way single M10x1 threads
43113-401	6 way single M10x1 threads
43115-101	4 way double M10x1 threads
43115-201	6 way double M10x1 threads
43115-301	8 way double M10x1 threads
43115-401	10 way double M10x1 threads

Misc Fittings	Description
41560-251	Blanking plug M10x1
41391-106	Sleeve nut 6mm tube x M10x1
41388-301	6mm olive

Progressive Systems

HDI Pump

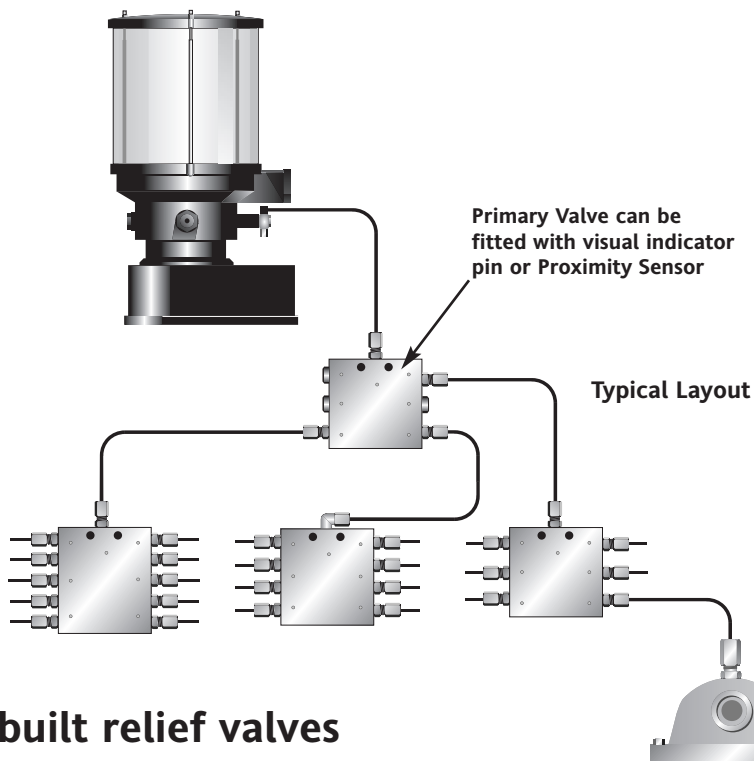

Pump elements with in-built relief valves



PU 300-350



PU 300-350-A

Standard HDI pump operates at 19/23revs/min				
Part No	Max output/min pressure (Bar/PSI)	Output/min Volume (cc) (cu in)		
PU 300-350	300 (4410)	3.2	(0.20)	Relief Valve Setting 350 BAR 5145 PSI
PU 300-350-A	300 (4410)	3.2-1.4	(0.20-0.08)	
PU 400-350	300 (4410)	3.2	(0.20)	
PU 400-350-A	300 (4410)	3.2- 1.4	(0.20-0.08)	
Operation conditions +40°C to - 30°C				
Pump Element Outlet Size 6mm OD				

Standard Progressive Divider Valves

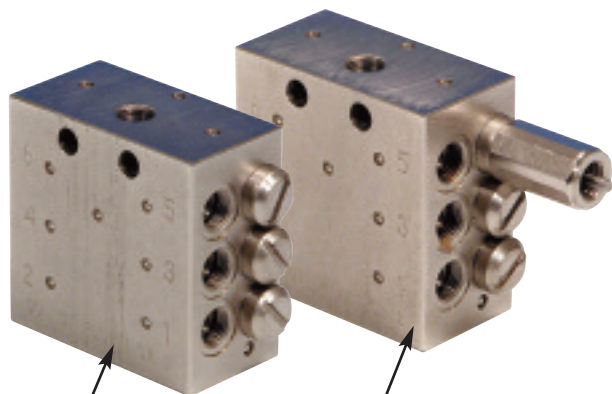

Standard Divider Valve

Divider valves with visual indicator pin

Part No	Number of outlets	Monitoring	Max flow per min
LSV-06	6		200 cc
LSV-06K	6	Indicator Pin	200 cc
LSV-08	8		600 cc
LSV-08K	8	Indicator Pin	600 cc
LSV-10	10		700 cc
LSV-10K	10	Indicator Pin	700 cc
LSV-12	12		800 cc
LSV-12K	12	Indicator Pin	800 cc
LSV-14	14		900 cc
LSV-14K	14	Indicator Pin	900 cc

Progressive Valve Fitted with Proximity Sensor

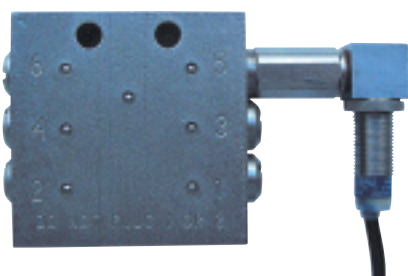

Divider Valve Fitted with a proximity sensor to monitor electrically the flow of lubricant

Progressive System Accessories

Proximity Adaptors



LSV36713-1

Proximity Switch



LSV 512-4482

Check Valve Outlet Fittings



Part No PU 300-350	Description
LSV - 30364 - 4	MIO X 1 Check valve body
LSV - 12374 - 9	coupling nut 6mm OD
LSV - 12295 - 2	Olive 6mm OD

Closure Plug



LSV- 17499-3

Fuse Holder (5 AMP)

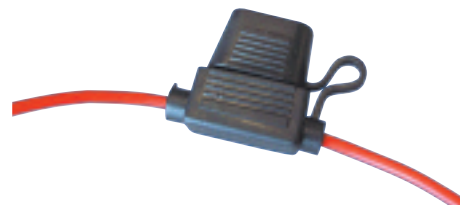

HDI - 13321-1

Push Button



12V HDI - 36070-5
24V HDI - 36070-6

Transformer Card 110/24VDC

(Available soon)

Replacement Control Card 12/24V

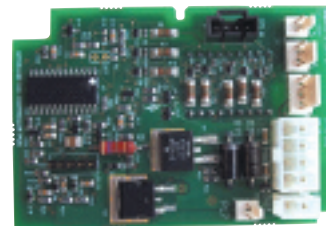

HDI/SP15

Low Level Sensor Conversion Kit

Details see page 5

Kit comprises of: Low level sensor, cable, plug, pump plug with internal loom to PCB

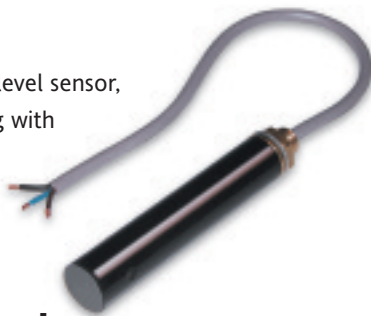

Part No	Description
HDI SP9/3P	Low level kit for 3Ltr moulded reservoir
HDI SP9/3	Low level kit for standard reservoir
HDI SP9/6	Low level kit for standard 6Ltr reservoir
HDI SP9/9	Low level kit for 9Ltr reservoir
HDI SP9/15	Low level kit for 15Ltr reservoir

Return to Tank



Part No	Description
34237-442	Pump outlet blanking plug
HDI-30698-1	Return to tank fitting
EXT-22025	Pump outlet fitting tapped 1/4" BSP (F)

Proximity sensor Conversion kit

Proximity alarm plug A plus pump plug with internal loom to PCB

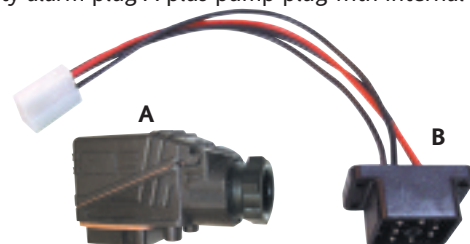

Part No	Description
HDI/SP9	Low level External Alarm Facility
A HDI/SP4	Power/push button plug with 10m cable
A+B HDI/SP8	proximity alarm plug

Major Radial/Minor Radial Grease Pumps



Heavy Duty Multi Outlet Grease Pumps

Major Radial	Minor Radial
Outlets: 1-30	Outlets: 4
Reservoir sizes: 4.5, 9, 27KG	Reservoir size: 3KG

Typical Applications

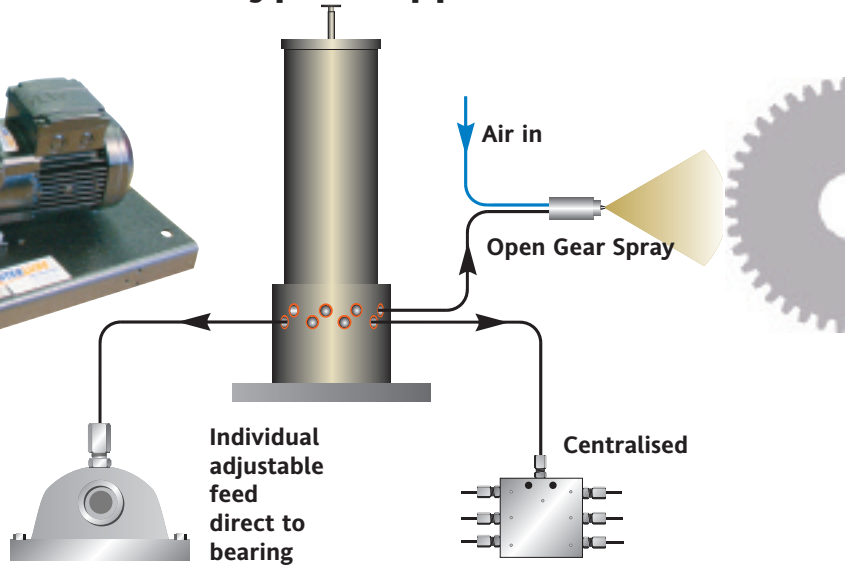

Major Radial Pumping Elements

Delivery per stroke 0.02-0.5cc
Maximum output pressure 100 Bar.



Part No	Description
67688	Pumping unit 3/8 OD tube
67688/106	Pumping unit 8mm OD tube
67688/107	Pumping unit 10mm OD tube
67688/108	Pumping unit 1/4BSP male
106050	Plug for unused outlets
28280	Washer for plug

Minor Radial Pumping Elements

Delivery per stroke 0 - 0.2cc
Maximum output pressure 70 Bar.



Part No	Description
67801	Pumping unit 1/4 OD tube
67801/103	Pumping unit 6mm OD tube
67801/108	Pumping unit 10mm OD tube
34232-207	Plug for unused ports

Compression Fittings

Male Connectors



Part No	Tube	Thread
25477-767	6mm	1/4 BSP
25477-906	6mm	M6x1
25477-916	6mm	M8x1
25477-926	6mm	1/8BSP
25477-936	6mm	M10x1
223-12272-9	10mm	1/4

Male Elbows



Part No	Tube	Thread
25477-905	6mm	M6x1
25477-915	6mm	M8x1
25477-925	6mm	1/8BSP
25477-935	6mm	M10x1
223-12380-6	6mm	1/4

Straight Coupling



Part No	Tube
LSV-12531-8	4mm OD
LSV-12482-9	6mm OD
LSV-12531-9	8mm OD
LSV-12531-2	10mm OD

Equal Tees

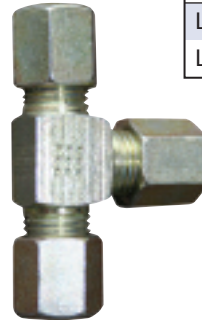

Part No	Tube
LSV-12563-5	4mm OD
LSV-12484-9	6mm OD

Reducing Connectors



Part No	Tube
LSV-1006	10mm to 6mm OD



Part No	
SWV-91303	STR Swivels M/F

Swivel Connectors 90°



Part No	Thread	Tube
SWV - 13756-7	M6x1	6mm
SWV - 13756-4	M8x1	6mm
SWV - 13756-5	M10x1	6mm
SWV - 13756-8	1/8 BSP	6mm
SWV - 52938/101	1/8 BSP	FxM
SWV - 52938	1/8 NPT	FxM

Single -Line (AX150) System



Single Line System serves up to 150 lubrication points with fluid grease

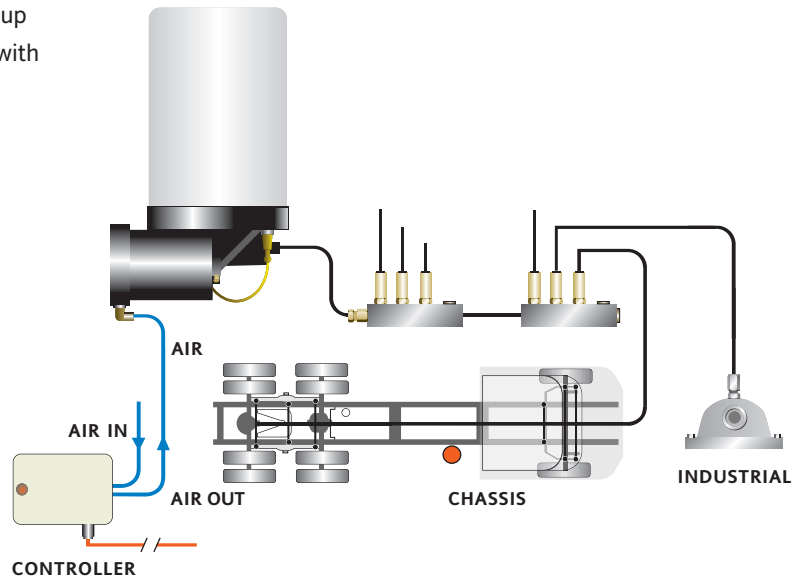

Controller



Part No	Description
AF 17472/12V/F	12V DC Controller
AF 17472/24V/F	24V DC Controller

Air inlet pressure 6 - 10 bar

On time - 1 min

Delay time options - 20, 45, 90 min 3, 4, 6 and 12 hours

Grease Meter Valves

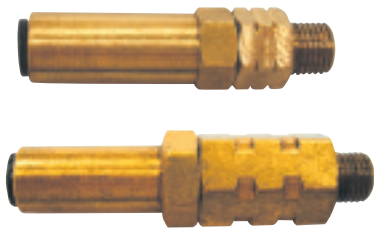

Part No	Description	Output per cycle (cu ins)
14 - 20624	0 Notch Valve	0.0005
14 - 20039	1 Notch Valve	0.001
14 - 20040	2 Notch Valve	0.003
14 - 20365	3 Notch Valve	0.005
14 - 20463	1 Notch Valve (Large)	0.010
14 - 20464	2 Notch Valve (Large)	0.020

Injector Manifolds



Part No	Description
14 - 20168S	2 Injector Manifold
14 - 20169S	4 Injector Manifold
14 - 20170A	5 Injector Manifold
14 - 20171A	6 Injector Manifold
14 - 20879A	7 Injector Manifold
14 - 21239A	8 Injector Manifold
14 - 21240A	9 Injector Manifold
14 - 21241A	10 Injector Manifold
14 - 21242A	11 Injector Manifold
14 - 20061	Unused Port Blank
14 - 20111	Blank Plug (End)

Single -Line (AX150) System

Feed Line Tube



Part No	Description
14-21293	5mm O.D nylon tube filled natural (30m coils)
14-21293B	5mm O.D nylon tube filled black (30m coils)
14-21254	5mm O.D nylon tube unfilled natural

High Pressure Main Line Hose



Part No	Description
14-21253	High pressure braided main line hose
14-20109	Sleeve for 1/4" O.D tube
14-20161	1/4" O.D Olive
14-21251	Ferrule for main line hose
14-21252	5mm standard for main line hose
14-21317	Sleeve nut for 5mm O.D tube
14-21394	1/4" O.D Standard for H/P tube

Straight Connectors Push-in Type for 5mm Tube

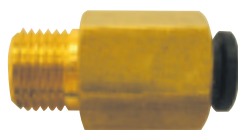

Part No	Thread Size
14-17929C	1/8 BSPT
14-21325C	M8 x 1
14-21326C	M10 x 1
14-50065C	1/8 NPT
14-21347C	M6 x1

Elbow Connectors Push-in Type for 5mm Tube



Part No	Thread Size
14-17106C	1/8 NPT
14-17107C	3/4 BSF
14-17109C	5/16 UNF
14-17110C	M8 x 1.25
14-17220C	M8 x 1
14-21154C	1/8 BSP swivel
14-21329C	M6 x 1
14-21335C	1/8 BSP
14-21342C	M10 x 1
14-50064C	1/4 UNF

Tee Piece Connectors



Part No	Description
14-21371	8mm O.D x 8mm O.D x 8mm O.D tee
14-20112	1/4" O.D x 1/4" O.D x 1/4" O.D tee
14-21219	Stem reducer 8mm to 5mm

Electric Keg Pump Systems

Electric Keg Pump



Pump part No 880-639 - 12.5 to 20KG (35lb)
880-639/1 - 180KG (400lb)

Pump to fit:

12.5 - 20 KG standard drums or 35lb pails
180 KG or 400lb pails. Down tube 835mm

Pump comprises of:

24V DC pump, follower, lid & clamps
Pump discharge 120grms/min
Maximum output 280 Bar
Voltage 24VDC

Operation

- Automatic Progressive System
- Injector System
- Hose Reel and/or Automatic System

Control Panel



Part No	Description	Voltage	Enclosure
Logic 123	Standard plant system controller with alarm	24V DC	Plastic
Logic 246	Industrial controller with alarm facility	110/240 V	Steel
Logic 480	Controller for plant system and override facility for hose reel	24V DC	Plastic

Control Panel Bracket

Special bracket for quick and easy mounting of the control panel and/or 3 way ball valve for the hose reel kit



Pump Bracket



Part No: 880-63BK

Special bracket to mount the electric keg pump and to keep the drum of grease stable on mobile plant applications designed for 12.5, 18 & 20kg drums

Retractable Hose Reel (10m)

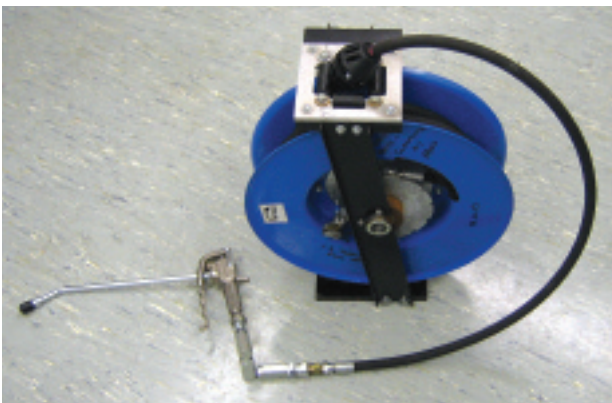

Hose reel with 10m high pressure hose, 3 way ball valve, interconnecting pipe work and fittings

Hose reel kit used in conjunction with the electric grease pump and 480 Logic Controller.

This gives an on site manual back-up facility for lubrication and can be used to lubricate bearings at the bottom end of Excavators/Face Shovels when lubrication system feed pipes are not conclusive.

Part No: HRK - 880
(hose reel only kit)

Grease Filler Pumps

Hand Operated Bulk Fill Pump



Hand operated bulk fill pump complete with:
1.5m hose, female quick release coupling to fit directly onto the Interlube quick connect fitting fitted to the pump.

Ideal for use with NLGI 1 or 2 greases.

Part No	Description
IL-108501	European Pump (12.5-18 KG), cover 265mm to 310mm
IL-108502	USA Pump (35lb) cover 285mm to 330mm
IL-417001	Grease follower plate 260mm to 298mm
IL-417003	Grease follower plate 300mm to 340mm

Quick Fill Gun



Hand Operated Quick-Fill Gun.

Quick, easy and simple method of filling grease reservoirs, minimising the likelihood of contamination

Part No	Description
HDI-57549-1	Quick Fill Gun
HDI-36763-1	Straight Adaptor
HDI-36763-2	90° Adaptor
HDI-36764-1	Long Straight Adaptor

(Use standard 400gm grease cartridges)



HDI-57549-1



HDI-36763-1



Pump mounted fittings straight/90 Degree

For Interlube Range of GREASE see page 17

High Pressure Grease Pumps

Air Operated Grease Pumps



Quality range of Interlube Air Operated Grease Pumps Kits comprise of:

- 50 : 1 Ratio pump
- Drum Cover
- Follower plate
- 4m Discharge hose and control valve
- 1.5m Air Hose
- Filter regulator and trolley

Fixed systems for large capacity drums, (same as mobile units without trolley)

Part No	Description
IL-417001	follower plate 298mm to 260mm
IL-417005	follower plate 300mm to 340mm
IL-417003	follower plate 417mm to 360mm
IL-417004	follower plate 590mm to 550mm

Part No	Keg Size	Description
IL-424150	12-18KG (35lb)	Mobile unit 310mm cover, 450mm down tube
IL-425150	50KG (120lb)	Mobile unit 405mm cover, 725mm down tube
IL-429000	180KG (400lb)	Static unit 610mm cover, 950mm down tube
IL-428243	180KG (400lb)	Mobile unit 610mm cover, 950mm down tube

Battery Operated Grease Guns



Superluber kit comprising of:

12V DC Grease gun suitable for bulk fill or cartridge, case, strap, two batteries and 220-240V battery charger.

Output pressure 7500 PSI/518 Bar

Part No	Description
LX-1163-E	Superluber kit complete
LX-1167	220V-240V charger
LX-1166	Field battery charger 12V
LX-1164	Spare battery



LX-1163-E

For Interlube Range of GREASES see page 17

Hand Operated Grease Guns & Grease Pumps

Heavy Duty Side lever Grease Gun



Part No	Description
IL-356PK	Heavy duty side lever grease gun suitable for bulk fill or 400gm cartridges. Grease gun fitted with air bleed valve and supplied with a 6" rigid stem and 4 jaw hydraulic connector.

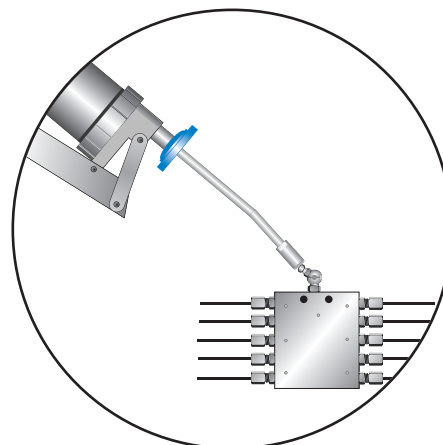

Hand Operated Grease Pump

Heavy duty hand pump suitable to operate progressive divider valves see page 7 & 8.

Part No	Description
IL-56400PK	Bracket mounted Hand Operated Grease Pump Reservoir capacity 500cc Bulk fill 400gm cartridges Maximum output: 300 bar Output per stroke 1.5cc/stroke

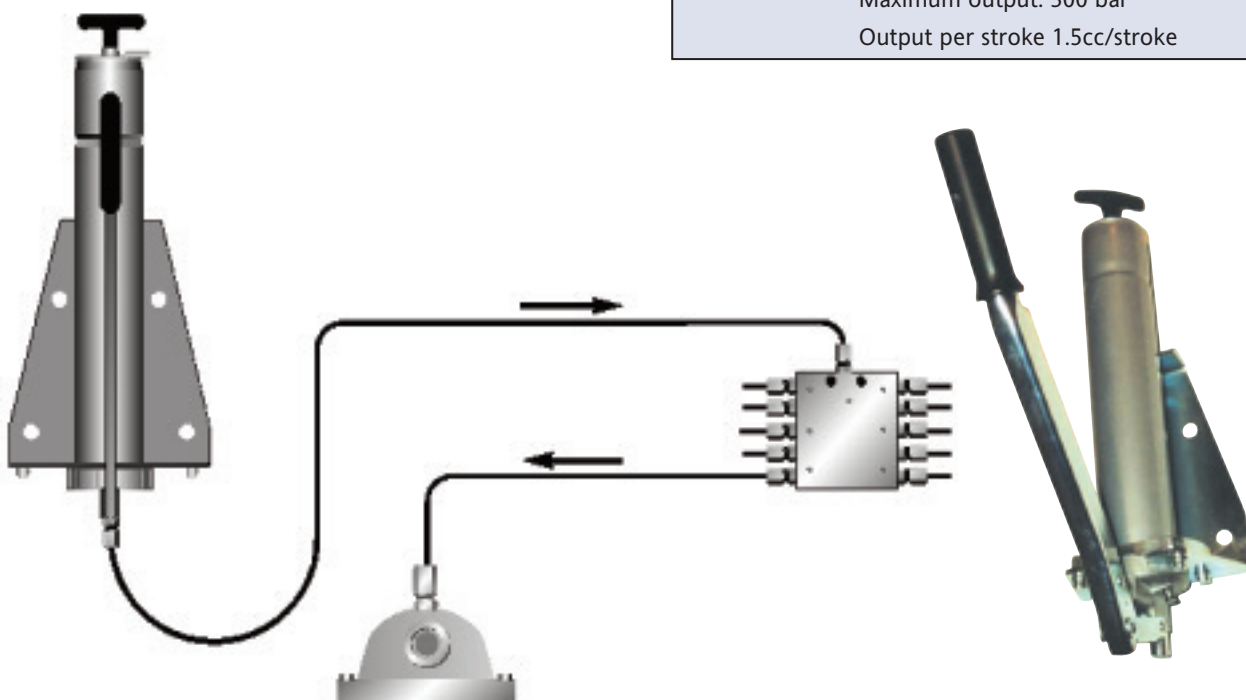

Grease

High Performance Lubricants



Cartridges



Kegs



1 litre Bottle

Interlube Range of Greases

NLGI 2 Grade (Heavy Grease)	
Part No	Description
25717-270/12.5kg	12.5kg drum
25717-270/20kg	20kg drum
25717-270/50kg	50kg drum
NLGI 000 Grade (Fluid Grease)	
25717-284	12 x 1 Litre bottles
25717-284/12.5kg	12.5kg drum
25717-284/20kg	20kg drum
25717-284/50kg	50kg drum

Grease	Description	Sizes Available					Temp Range Deg C°
		400gm	12.5kg	20kg	50kg	180kg	
Hammer paste	For hammer lubrication	✓	✓	✓	✓	✓	-10 to + 160
Pin & bush EP2	For tractor 5th wheel, slewing ring	✓	✓	✓	✓	✓	-20 to + 140
Multipurpose EP2	Centralized lubrication system	✓	✓	✓	✓	✓	-20 to + 140
Watershield EP2	Extreme water conditions	✓	✓	✓	✓	✓	-20 to + 150
Synthetic H/T EP2	High temperature applications	✓	✓	✓	✓	✓	-40 to + 220
Food grade EP2	Food applications FSH approved	✓	✓	✓	✓	✓	-50 to + 165
Heavy plant grease	Centralized systems on heavy plant	✓	✓	✓	✓	✓	-30 to + 150
FG fluid grease 000	Centralized lubrication		1 LTR Bottle				-35 to +40
FG fluid grease 000	Centralized lubrication		✓	✓			-35 to +40

Heavy Duty Plant Grease



A premium quality grease for lubrication points via centralised lubrication systems on static and mobile plant

The grease has:

- Anti - wear additives
- Excellent load carrying properties
- Resistant to water washout
- Resistant to salt & chemicals
- Wide temperature range -30 to +150

All the above help to prolong the life of the grease so re-lubrication does not have to be carried out as often. This reduces grease consumption and is better for the environment

Standard Adaptors and Anchor blocks

Reducing Adaptors

Part No	Description	Length mm X
EXT-20024	1/8" BSP(F) x 1/4" UNF(M)	22
EXT-010461	1/8" BSP(F) x 1/4" UNF(M)	16
EXT-020011	1/4" BSP(F) x 3/8" UNF(M)	16.5
EXT-191671	1/8" BSP(F) x M8 x 1(M)	22
EXT-197871	M8 x 1(F) x M6 x 1(M)	18

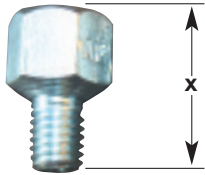

Extension Pieces

Part No	Description	Length mm X
EXT-2-23	1/8" BSP(M)x(F)	23
EXT-2-35	1/8" BSP(M)x(F)	35
EXT-250	1/8" BSP(M)x(F)	50
EXT-19437-1	M8 x 1 (M)x(F)	18

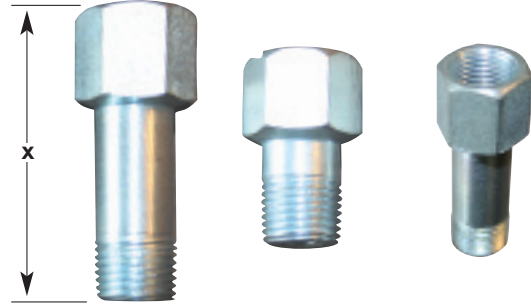

45 Degree Adaptors

Part No	Description	Length mm (x)
EXT-20028	1/8" BSP(M) x 1/8" BSP(F)	23
EXT-24050-1	M8x1(M) x M8 x 1(F)	23

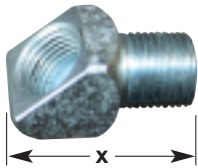

90 Degree Adaptors

Part No	Description	Length mm X
EXT-020029	1/8" BSP(F) x 1/8" BSP(M) (Long)	23
EXT-020026	1/8" BSP(F) x 1/4" UNF(M)	21
EXT-24043-1	M8 x 1(F) x M8 x 1(M)	23

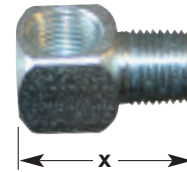

Anchor Blocks

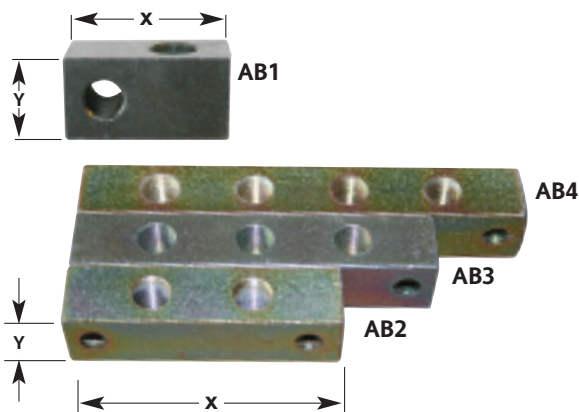

Part No	Description	Length mm	
		X	Y
AB1	1 Way 1/8" BSP (F)	32	16
AB2	2 Way 1/8" BSP (F)	62	16
AB3	3 Way 1/8" BSP (F)	86	16
AB4	4 Way 1/8" BSP (F)	108	16
AB5	5 Way 1/8" BSP (F)	132	18
AB6	6 Way 1/8" BSP (F)	154	16

All Anchor Blocks are steel plated, use standard M6x1 fixing bolts

3 - Way Anchor Block

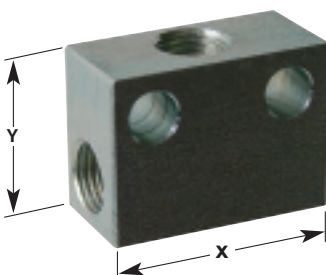

Part No	Description	Length mm	
		X	Y
A118203	3 Way 1/4" BSP	40	30

Pipe & Tube

Nylon Tube



Part No	Burst Pressure	Description
152823/25	140 bar	4mm OD black tube filled with NLGI 000 grade x 25m
152823/50	140 bar	4mm OD black tube filled with NLGI 000 grade x 50m
152821/25	140 bar	4mm OD black tube filled with NLGI 2 grease x 25m
152057/50	140 bar	4mm OD black tube unfilled x 50m
152057/100	140 bar	4mm OD black tube unfilled x 100m
152826/25	140 bar	4mm OD black tube filled with food grade grease x 25m
136782	75 bar	6mm OD black tube unfilled x 100m coil
152820/25	75 bar	6mm OD black tube filled with NLGI 2 grease x 25m
136873	68 bar	4mm OD natural tube unfilled 100m coil
151083	68 bar	8mm OD black tube unfilled 100m coil
136558	68 bar	6mm OD natural tube unfilled 100m coil
152058	70 bar	5mm OD black tube unfilled 100m coil

Nylon Tube (High Pressure) Polyimide Tube



Part No	Tube Ø(mm)	Coil	Burst Pressure
LSV-36041-2	6mm O.D x 1.5mm wall Grease filled	(30m)	250 bar
LSV-35127-2	6mm O.D x 1.5mm wall Unfilled	(30m)	250 bar

8.6mm High Pressure Braided Tube



Part No	Tube Ø(mm)	Coil	Burst Pressure
HP-36033-3	8.6mm OD x 2.3mm wall Grease Filled	(50m)	250 bar
HP-35114-1	8.6mm OD x 2.3mm wall Unfilled	(50m)	250 bar
HPC-35114-1	8.6mm OD x 2.3mm wall Low cost tube Unfilled	(50m)	250 bar

Heavy Duty 2RT Braided Hose

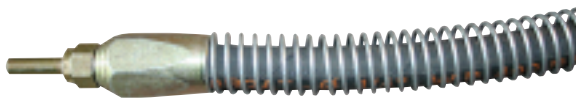
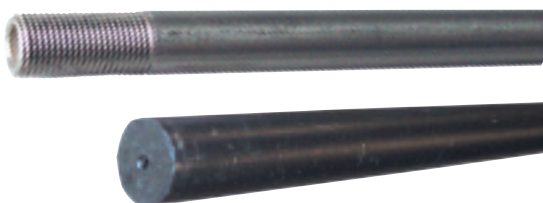

Illustration shows 2RT Hose with steel helix protection (shown on page 20)

Part No	Description
2RT Hose	Two wire double braided flexible hose idea for heavy plant applications that are prone to site damage

Steel Tube



Part No	Description
1178-102	4mm O.D (3m Length)
1178-124	6mm O.D Steel bundy (3m Length)
1178-100	10mm O.D Steel bundy (3m Length)
1178-200	10mm O.D Thick wall tube (1.5m Length)

Pipe & Tube Accessories

Re-usable Studs and Sleeves

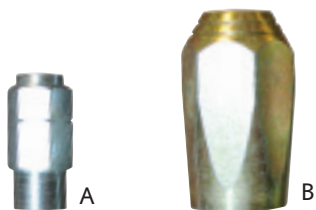

Part No	Description
A). *LSV-23031-1	Re-usable sleeve for 8.6mm HP pipe
B). FHF-FER-2RT-R-B	Re-usable sleeve for Heavy Duty 2RT Hose
C). *LSV-24162-1	Re-usable stud for 8.6mm H/P pipe (6mm O.D)
D). FHF-RPM-2-B06	Re-usable stud for Heavy Duty 2RT Hose (6mm)
E). *LSV-30738-1	Re-usable 90 Deg stud for 8.6 Hose (Long)
*LSV-30739-1	Re-usable 90 Deg stud for 8.6 Hose

*For stainless steel prefix with SS

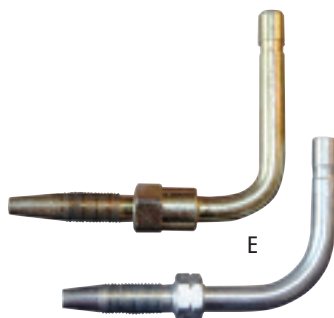
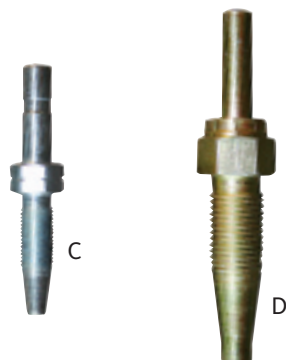

Protective Helix Plastic and Steel

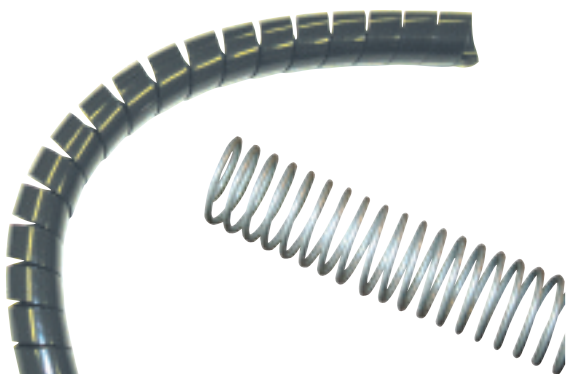

Part No	Description
LSV-35075-3	Plastic Helix (12mm) (see page 3 for additional sizes)
Steel Helix Small	10mm Steel Helix
Steel Helix Medium	20mm Steel Helix
Steel Helix Large	40mm Steel Helix

P Clips



Part No	Description
PC-12557-1	6mm P Clip
PC-12557-7	10mm P Clip
PC-12557-3	13mm P Clip
PC-12557-4	16mm P Clip
PC-12557-6	21mm P Clip
PC-12557-7	25mm P Clip

10mm OD fixing hole

Pipe Clips



Part No	Description
120859	1 way for 4mm tube
3821	2 way for 4mm tube
3822	3 way for 4mm tube
120863	1 way for 6mm tube
120864	1 way for 10mm tube

Special Brackets for Plant

Central Bracket

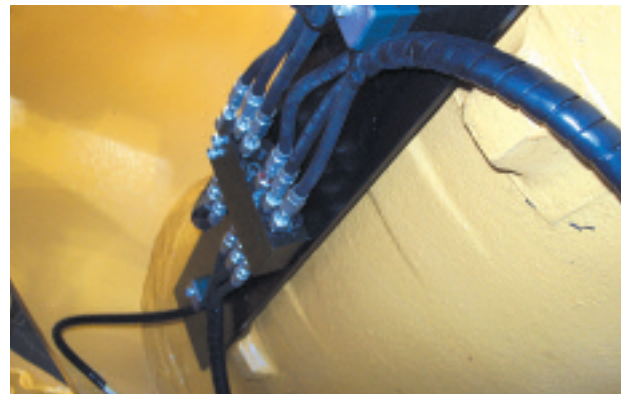
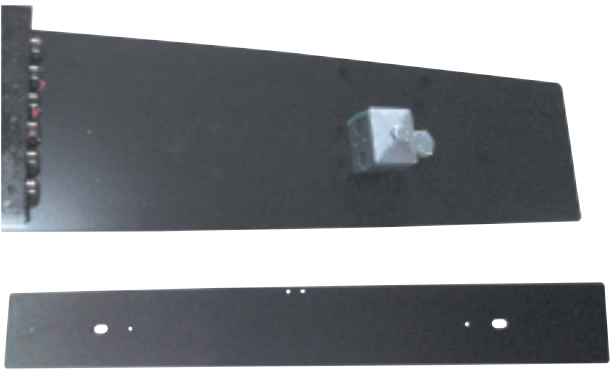

Tee Bracket



Link Arm brackets



Steering Bracket



Special Brackets for Plant

Special Adaptors for Plant

Bearing Inlet Adaptors



CAT 1 CAT 980H CAT LONG



Inlet adaptor designed to protect the compression fitting

Insert Adaptors



Part No	Description	Length mm (Y) ϕ	
CAT/INSERT	Bearing insert for 10mm thick tube	30	20
CAT/INSERT 10mm	Adaptor threaded M10 x 1 for the central bracket on page 21	15	25
WS-10	Welded Adaptor threaded M10 x 1 for Tee Bracket	30	18
WS-10D	Double weld adaptor threaded M10 x 1 double length	60	18

Bearing Insert Adaptor for 10mm thick tube

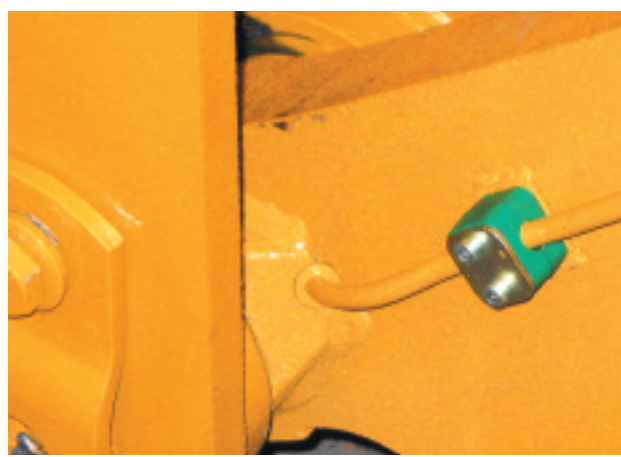

Pipe Clamps



Part No	Description
SC-9.5 Single	Pipe Clamp 9.5mm Single pipe
SC-9.5 Double	Pipe Clamp 9.5mm Double pipe
SC-12 Double	Pipe Clamp 12mm Double Pipe
SC-16 Single	Pipe Clamp 16mm Single Pipe
SC-16 Double	Pipe Clamp 16mm Double Pipe

Weld Plates for LSV Divider Valves



Part No	Description
Block Plate 6	Weld Plate for LSV-06 Divider Valve
Block Plate 8	Weld Plate for LSV-08 Divider Valve
Block Plate 10	Weld Plate for LSV-10 Divider Valve
Block Plate 12	Weld Plate for LSV-12 Divider Valve

Miscellaneous Fittings

Straight Connectors



Part No	Tube size	Thread
LE 80512	4mm	1/8 NPT
LE 80584	4mm	1/4 x 28UNF
LE 80585	4mm	5/16 x 24UNF
LE 80587	4mm	1/8 BSPT
LE 80589	4mm	M6 x 1
LE 80590	4mm	M8 x 1
LE 80591	4mm	M8 x 1.25
LE 80592	4mm	M10 x 1
LE 80687	3/16in	1/8 BSP
LE 80887	1/4in	1/8 BSP
LME 70605	6mm	M8 x 1 (To fit into Manifolds)

Elbow Connectors



Part No	Tube size	Thread size
LE 90512	4mm	1/8 NPT
LE 90584	4mm	1/4 x 28UNF
LE 90585	4mm	5/16 x 24UNF
LE 90587	4mm	1/8 BSPT
LE 90589	4mm	M6 x 1
LE 90590	4mm	M8 x 1
LE 90591	4mm	M8 x 1.25
LE 90687	3/16	1/8 BSP
LE 90887	1/4	1/8 BSP
LE 90888	1/4	1/4 BSP
LE 91088	5/16	1/4 BSP
LE 91288	3/8	1/4 BSP

Double Ended Connectors



Part No	Tube size	Description
25478-056	4mm	Push fit connector
LE 505	4mm	Compression type
LE 508	1/4	Compression type
LE 510	5/16	Compression type
LE 512	3/8	Compression type
LM 506	6mm	Compression type

Tee Assemblies



Part No	Tube size	Description
LE 05	4mm	Compression type
LE 06	3/16	Compression type
LE 10	5/16	Compression type
LM 06	6mm	Compression type

Miscellaneous Fittings

Bulkhead Connectors

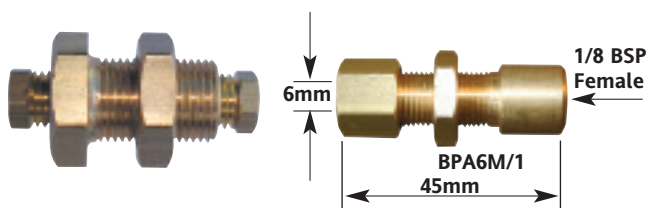

Part No	Tube size	Description
LE 60525	4mm	For 6mm plate
LE 60550	4mm	For 13mm plate
7616/1	4mm	For 3mm plate
7616/2	4mm	For 16mm plate
BPA6M/1	6mm x 1/8" BSF (F)	

Sleeve Nuts



Part No	Description
LE 305	For 4mm (5/32) tube 5/16 x 24 UNF thread
LE 306	For 3/16 tube 3/8 x 24 UNF thread
LE 308	For 1/4 tube 7/16 x 20 UNF thread
LE 310	For 5/16 tube 1/2 x 20 UNF thread
LE 312	For 3/8 tube 9/16 x 18 UNF thread
LM 304	For 4mm tube M8 X 1 thread
LM 306	For 6mm tube M10 X 1 thread
LM 308	For 8mm tube M12 X 1 thread
LM 310	For 10mm tube M16 X 1.5 thread

Cones



Part No	Description
LE 205	For 4mm (5/32) tube
LE 206	For 3/16 tube
LE 208	For 1/4 tube
LE 210	For 5/16 tube
LE 212	For 3/8 tube
LM 206	For 6mm tube
LM 308	For 8mm tube
LM 210	For 10mm tube

Blanking Plugs



Part No	Description
LE 405	For manifold fitting 5/16 x 24UNF thread
LM 404	For manifold fitting M8 x 1 thread
100727	With 1/8 BSP thread
102017	With 1/4 BSP thread
34237-402	For AC/AX/XGS pumps M12 x 1 thread

Brushes



A410



A400



23115-102

Part No	Description
23115-102	18mm flat nylon 1/8 BSP
A400	20mm Dia nylon 1/4 BSP
A410	40 x 30 Flat nylon 1/4 BSP
A411	60 x 30 Flat nylon 1/4 BSP
A412	100 x 30 Flat nylon 1/4 BSP
83334-204	30mm flat nylon 4mm tube

Filtakleen By-Pass Oil Filtration

Hydraulic System Fitment

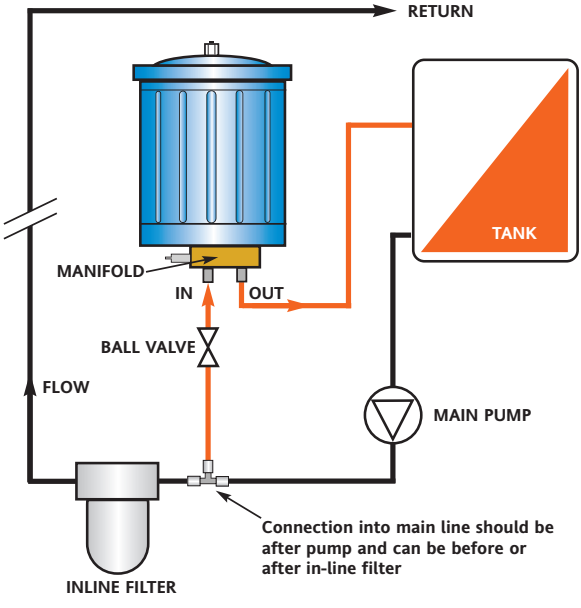

Engine System Fitment

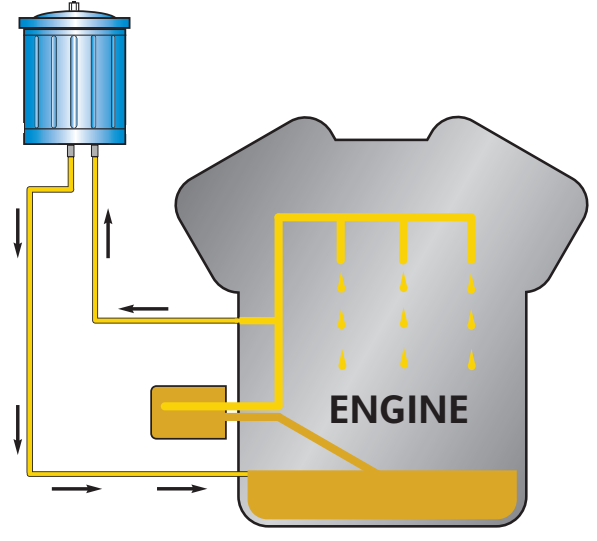

Replacement Filter Cartridges

Part No	Description	System size	Box size
Hydraulic Systems			
HYC78	Heavy duty filter	900 litre tank	12
MYC88	Maxi duty filter	2000 litre tank	6
Engine Systems			
C58	Bantam duty filter	8 litre sump	18
C68	Light duty filter	14 litre sump	12
HYC78	Heavy duty filter	36 litre sump	12
MYC88	Maxi duty filter	72 litre sump	6



Other Spares

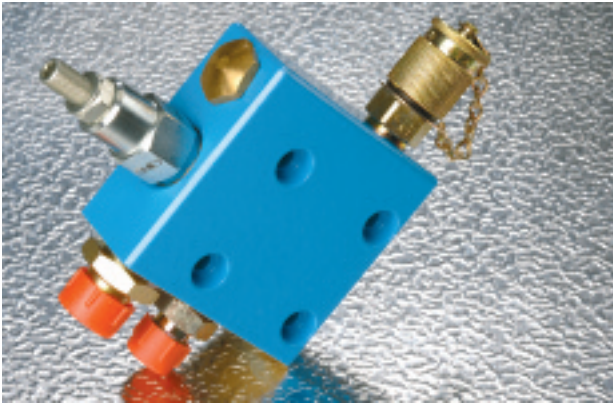

Part No	Description
17-17067A	1/4 BSP ball valve
17-17016A	Manifold block
17-17092	1/4 BSP swept elbow
17-17052	1/4 BSP insert
17-17070	3/8 BSP swept elbow
17-17072	3/8 BSP insert
17-17060	3/8 BSP 90 elbow
17-17091	1/4 BSP 90 elbow
17-17056	1/4 RI, ferrule
17-17055	3/8 RI, ferrule
17-17054	1/4 R2 insert
17-17069	1/4 BSP 90 swivel
17-17076	1/4 BSP x 1/4 BSP male adaptor
17-17074T	1/8 BSP x 1/4 BSP male adaptor

Filtakleen By-Pass Oil Filtration

Other Interlube Group Products

NEW PRODUCT



The RotaLube is a "Patented" applicator, specifically designed to apply lubricant accurately, to the pins on a chain, irrespective of chain speed or operating conditions.

The Rotalube means lubricating chain, via brushes or spit/spray application is now a thing of the past.

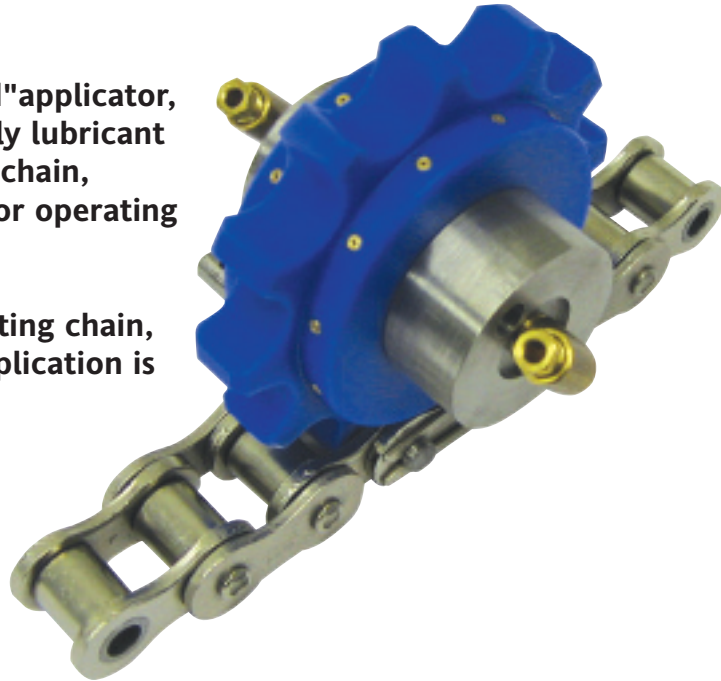

Leaders in Lubrication Solutions

Self Retracting Hydraulic Hose Reels

Tecreel - conveying hydraulic power from fixed to moving points

TECREEL by Interlube Systems Ltd

Oil filtration systems

Mobile Filtration Units

Filtakleen - Leaders in Oil filtration systems

Other Interlube Group Products



Interlube Systems Limited Manufacturing and Distributing Equipment throughout the World

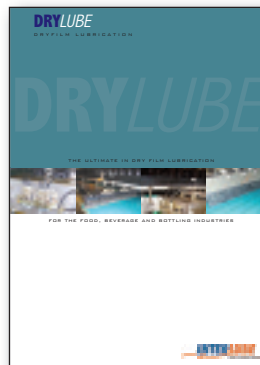
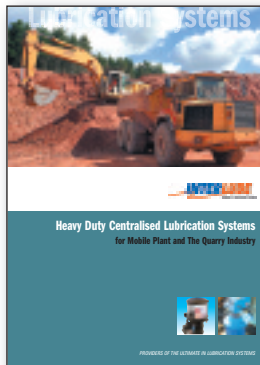
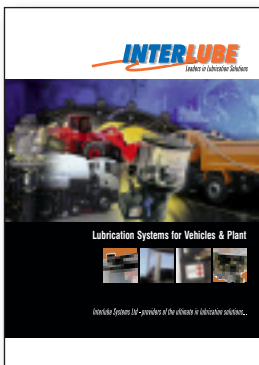

Distributed By

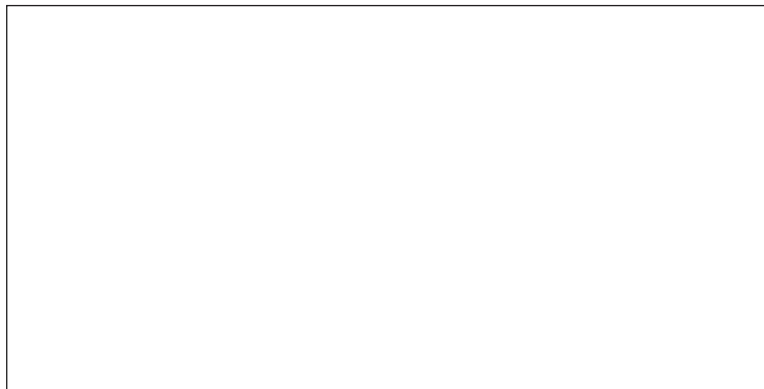

Part of the

Interlube Group

www.interlubesystems.com



ISSUE 13-09/2010